

Instruction Manual

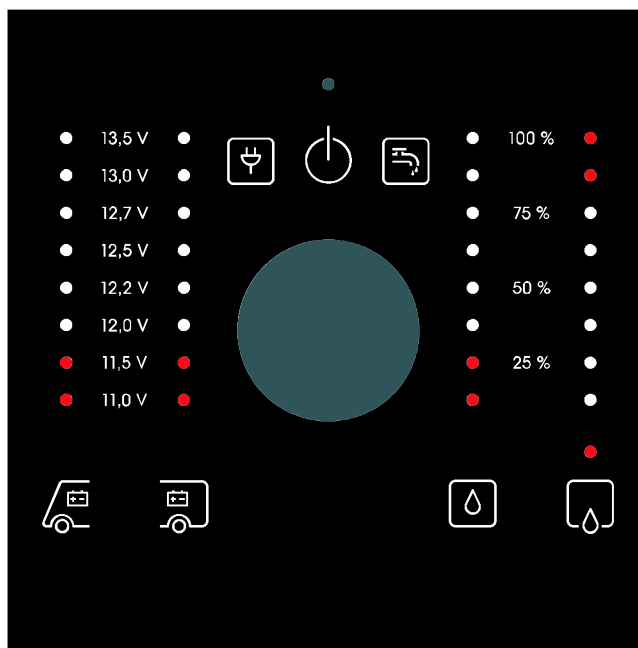

LT 50 Control Panel

Table of contents

1	Purpose	2
2	Layout	3
3	Operation	3
3.1	Switching on and off the 12V supply for the leisure area	3
3.2	Switching on and off the 12V supply of different consumers	4
3.3	Displays	5
3.4	Shutting down	7
4	Alarms and faults	8
4.1	Alarms	8
4.2	Faults	9
5	Technical details	10
6	Maintenance	10
7	Cleaning	10

1 Purpose

The LT 50 control panel is the central control and display device for the 12V supply and charging system within the vehicle.

These operating instructions contain important information on the safe operation of devices from Schaudt and should be kept in the vehicle at all times.

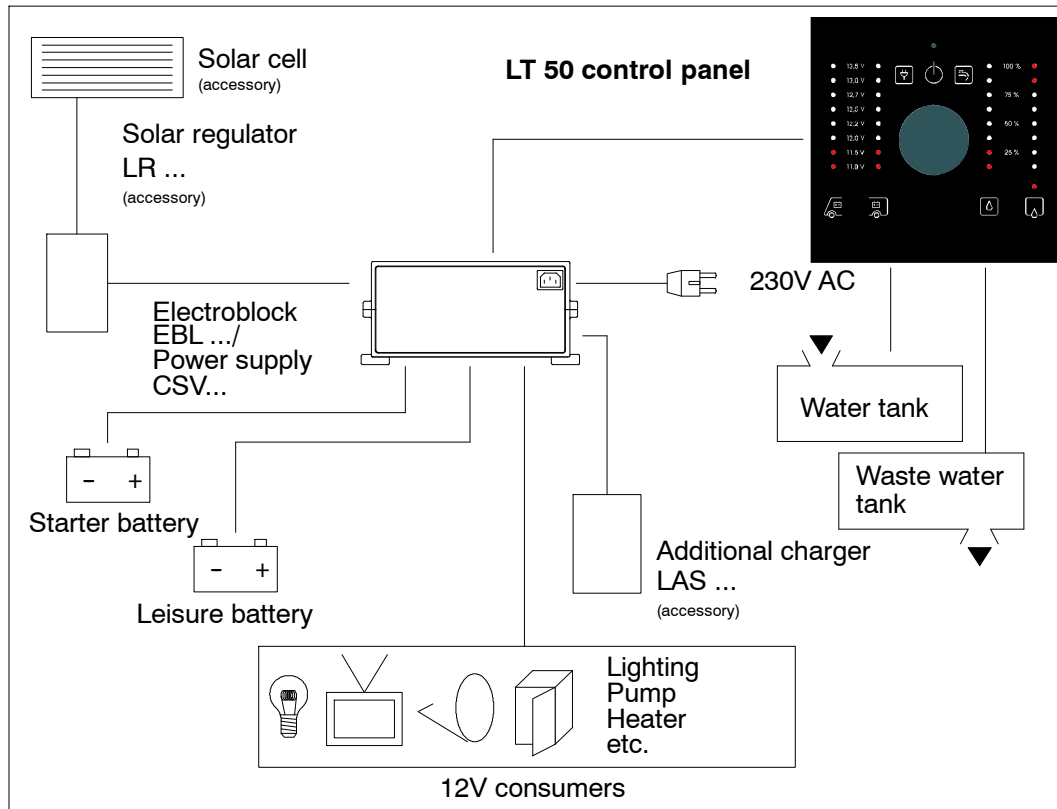

Fig. 1 12V on-board bus charging and supply system

System devices

- LT 50 control panel
- EBL ... electroblock (for motorhomes) or CSV... power supply (for caravans)
- Sensors and/or probe for water tank
- Sensors or probe for waste water tank
- Other potential accessory devices

2 Layout

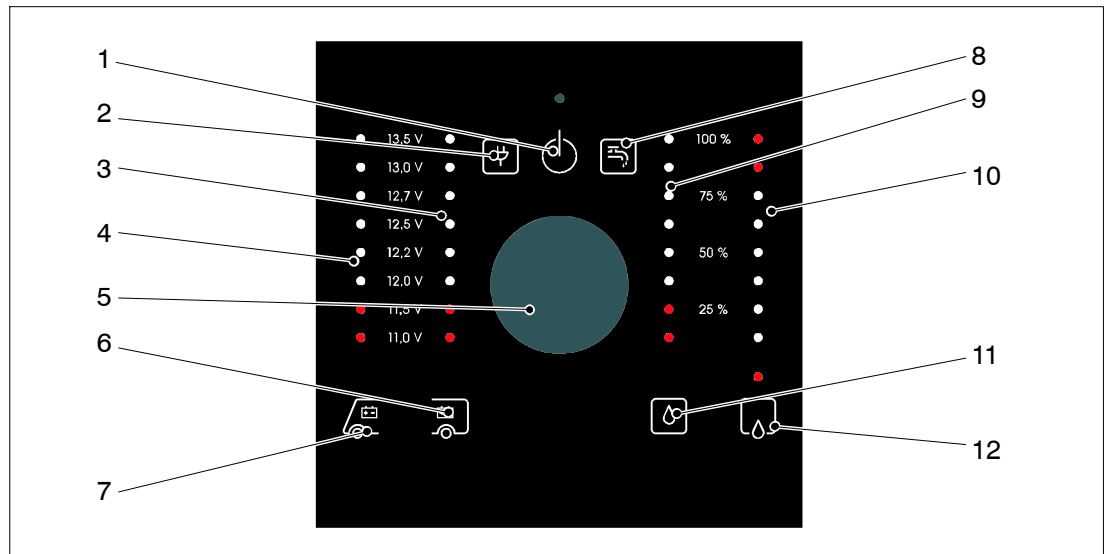

Fig. 2 LT 50 layout

- | | |
|---------------------------------------|--|
| 1 "12V ON" symbol | 7 "Starter battery" symbol |
| 2 "Mains indicator" symbol | 8 "Water pump" symbol |
| 3 "Leisure battery voltage" LED scale | 9 "Water tank fill level" LED scale |
| 4 "Vehicle battery voltage" LED scale | 10 "Waste water tank fill level" LED scale |
| 5 Rotary/press-in encoder | 11 "Water tank" symbol |
| 6 "Leisure battery" symbol | 12 "Waste water tank" symbol |

3 Operation



The only control on the LT 50 is a rotary/press-in encoder. Rotate and press it in to select displays and run switch functions.

3.1 Switching on and off the 12V supply for the leisure area

The 12V leisure area supply is connected via the encoder.

Exceptions here are consumers requiring constant power when the motorhome or caravan is being used.

Just which consumers these are depends on the combination used (LT 50/power supply) - also refer to the operating manual for the EBL ... and CSV ...):

- LT 50 with CSV 410-2 (caravans)
- LT 50 with EBL 208 (motorhome)
- LT 50 with EBL 226 (motorhome)

Switching on and off

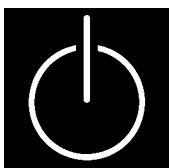

➤ Briefly press the encoder.

- The "12V ON" symbol illuminates - the 12V supply to the leisure area is on.
If the LT 50 control panel does not respond, either shutdown is active (for EBL 208 and CSV 410-2; see section 3.4 for how to cancel it) or the battery is discharged (fully charge the battery if required).
If the "12V ON" and "Leisure battery" symbols flash 3 times, shutdown is active (see section 3.4 for how to cancel it).
- The "12V ON" symbol goes out - the 12V supply to the leisure area is switched off.

Switching off is only possible when the "12V ON" symbol is on.



3.2 12V supply to the different consumers - switching on and off

Power to the following consumers can be switched on and off individually:

- Water pump
- Tank heater

The 12V supply for the leisure area must be switched on for these functions (see section 3.1).



The LT 50 switches to idle mode about 10 seconds after an operation. Lighting up of the relevant symbol or LED then indicates the switch states.



Water pump

- Turn the encoder until the fill level of the water tank is displayed on the LED scale.
 - The current switch state is shown by the "Water tap" symbol.
- Press the encoder.
 - The switch state changes (symbol lights or goes out): The 12V supply to the water pump is switched on/off.

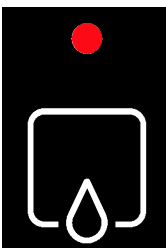

Tank heater, waste water tank

- Turn the encoder until the fill level of the waste water tank is displayed on the LED scale.
 - The red LED above the "Waste water tank" symbol shows the current switch state.
- Press the encoder.
 - The switch state changes (LED lights or goes out): The tank heater is switched on or off.

When the 12V supply to the leisure area is switched off, the power supply for the water pump is also switched off. The switch state of the "Waste water tank heater" remains unchanged (the red LED goes out when the 12V supply is disabled but the tank heater *may remain on*).

3.3 Displays

3.3.1 Mains indicator

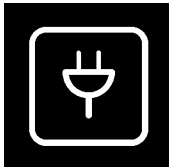

The "Mains indicator" symbol lights up when 230V mains voltage is being applied to the 12V charging system. The batteries are charged.

The display is only shown when the 12V supply for the leisure area is switched on ("12V ON").

3.3.2 Battery voltages

The 12V supply for the leisure area must be switched on for the display (see section 3.1).



➤ Turn the encoder until the "Leisure battery" symbol lights up.

- The "Volt" scale lettering lights up.
- The voltage of the leisure battery is displayed on the LED scale for approx. 20 seconds.



The following display function only exists for motorhomes because caravans have no vehicle battery.



➤ Turn the encoder until the "Starter battery" symbol lights up.

- The "Volt" scale lettering lights up.
- The voltage of the starter battery is displayed on the LED scale for approx. 20 seconds.



CAUTION!

Batteries (regardless of type) can be damaged permanently, possibly beyond repair, when fully discharged. So therefore:

- Avoid low battery charge (indicated by low voltage)
- Check the voltage regularly (see section 3.3.2)



It is best to carry out checks in the morning before 12V consumers are switched on.



The following table shows how to correctly interpret the leisure battery voltage.

Battery-voltage	Battery operation	Mobile operation	Mains operation
		Vehicle stationary, no 230V connection	Vehicle moving
Up to 11V Risk of total discharge (see above)	When consumers are switched off: battery flat	The alternator is not charging the battery	The EBL ... electroblock is not charging the battery
	When many consumers are switched on: possible battery overload	12V vehicle power supply overloaded	12V vehicle power supply overloaded
11.5V to 13.2V	Normal range	1. No charging by the alternator ¹⁾ 2. 12V vehicle power supply overloaded ¹⁾	1. No charging by the EBL ... electroblock ¹⁾ 2. 12V vehicle power supply overloaded ¹⁾
13.2V and over	Only occurs briefly after charging	Battery is charged	Battery is charged

¹⁾ If the voltage does not exceed this range for several hours.

The values specified above apply for running operation, not for the off-load voltage (see below).

Off-load voltage

Apart from displaying the battery capacity (see section 3.3.2), measuring the off-load voltage is a simple and effective method of checking the condition of the battery. Off-load voltage is understood to be the voltage of the charged battery in a passive state, with no current being supplied or drawn.

Take the measurement several hours after the last charging. No significant load should have been placed on the battery in the interim period, meaning no current should have been drawn from it. If the off-load voltage of the battery is less than 12.0V, there is a risk of total discharge.

The following table shows the correct interpretation of the off-load voltage displayed. The values specified apply for Gel batteries.

Values for off-load voltage	Charge state of the battery
Less than 12V	Totally discharged
12.2V	Approx. 25%
12.3V	Approx. 50%
More than 12.8V	Full

3.3.3 Tank fill levels

The 12V supply for the leisure area must be switched on for the display (see section 3.1).

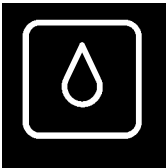

- Turn the encoder until the "Water Tank" symbol lights up.
 - The "%" scale lettering lights up.
 - The "Water Tank" symbol lights up (or flashes).
 - The fill level of the water tank is displayed on the LED scale for approx. 20 seconds.

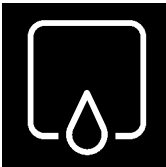

- Turn the encoder until the "Waste Water Tank" symbol lights up.
 - The "%" scale lettering lights up.
 - The "Waste Water Tank" symbol lights up (or flashes).
 - The fill level of the waste water tank is displayed on the LED scale for approx. 20 seconds.

If the relevant symbol flashes when the fill level of a tank is being displayed, the water tank is empty (or the waste water tank full).

If the LEDs flash, there is a sensor fault on the relevant tank (see section 4.1).

3.4 Closing down

A shutdown is understood to be the isolation of the 12V charging system and all consumers from the batteries. Exceptions:

- Devices charging the leisure battery continue to be connected (such as a solar regulator)

The LT 50 control panel is operated at different supply devices. These are the following depending on vehicle model (motorhome or caravan):

- For caravans:
 - CSV 410-2 caravan power supply
- For motorhomes:
 - EBL 208 electroblock
 - EBL 226 electroblock

➤ Shutdown and re-enable as follows:

Vehicle	Caravan	Motorhome	Motorhome
Operation on	CSV 410-2	EBL 208	EBL 226
LT 50	-	-	<ul style="list-style-type: none"> ➤ Disable 12V supply ➤ Press and keep pressed the encoder <ul style="list-style-type: none"> ● Symbols "Leisure battery" and "12V ON" flash three times after about 10 seconds ● Shutdown performed Cancelling the shutdown: ➤ Press and keep pressed the encoder <ul style="list-style-type: none"> ● Symbols "Leisure battery" and "12V ON" flash three times after about 5 seconds ● Shutdown cancelled ● 12V supply enabled ➤ Release the encoder
At the relevant power supply unit CSV ... / EBL ...	-	<ul style="list-style-type: none"> ➤ Move the "Battery" battery isolator on the EBL 208 to the "OFF" position <ul style="list-style-type: none"> ● Shutdown performed Cancelling the shutdown: ➤ Move the "Battery" battery isolator on the EBL 208 to the "ON" position <ul style="list-style-type: none"> ● Shutdown cancelled 	-
On the supply battery (caravan) or leisure battery (motorhome)	<ul style="list-style-type: none"> ➤ Unplug the battery connector (Molex Minifit SR) on the CSV, unlatching the side lock on the connector in the process. <ul style="list-style-type: none"> ● Shutdown performed Cancelling the shutdown: ➤ Insert the battery connector (Molex Minifit SR) on the CSV. <ul style="list-style-type: none"> ● Shutdown cancelled 	-	-

4 Alarms and faults

4.1 Alarms

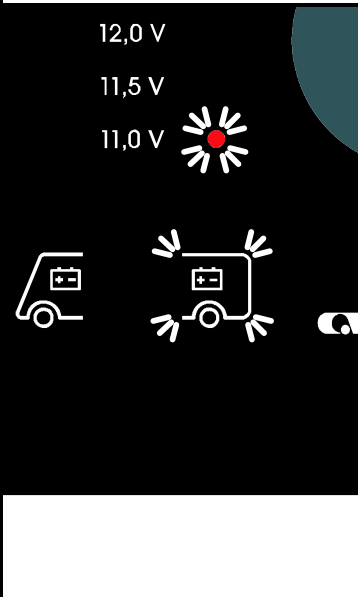
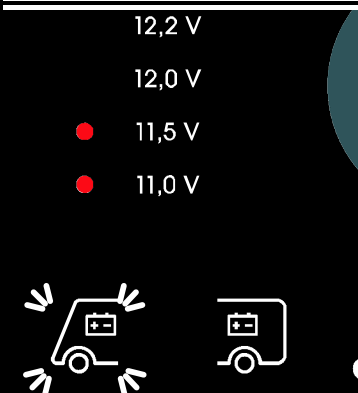

It is best to carry out checks in the morning before 12V consumers are switched on.

Alarm	Possible cause	Remedy
<p>The LT 50 LED panel switches off by itself.</p> <p>The "11.0V" LED and the "Leisure battery" symbol flash on trying to switch on the LT 50 LED panel (only EBL 226).</p>	<p>Risk of draining the leisure battery.</p> <p>Voltage of the leisure battery has fallen below 10.5V.</p>	<p>The battery monitor in electroblock EBL ... automatically switches off all consumers.</p> <p>The battery must be charged immediately (see above).</p> <p>See the electroblock EBL... instruction manual. .</p>
	<p>When the LT 50 LED panel is switched on or off:</p> <ul style="list-style-type: none"> - Voltage of the leisure battery too low (less than 11.0V) - Voltage of the leisure battery has fallen below 11.0V <p>When the LT 50 LED panel is switched off:</p> <ul style="list-style-type: none"> - The LT 50 LED panel, and hence the 12V supply to the leisure area, can no longer be switched on (to protect the battery) when the leisure battery voltage is less than 10.5V. - The "11.0V" LED and the "Leisure battery" symbol flash on trying to switch on the LT 50 LED panel (only EBL 226). 	<p>Switch off all 12V consumers.</p> <p>Charge the battery:</p> <ul style="list-style-type: none"> - Start engine or - connect to 230V power supply
	<p>Not for CSV 410-2:</p> <p>When the LT 50 LED panel is switched on or off:</p> <ul style="list-style-type: none"> - Voltage of the starter battery too low (less than 11.5V) <p>When the LT 50 LED panel is switched on and on display of the "Starter Battery" voltage:</p> <ul style="list-style-type: none"> - The two red LEDs (for 11 ... 11.5V) light up, or only the lowermost LED (starter battery voltage less than 11.0V). 	<p>Charge the battery:</p> <ul style="list-style-type: none"> - Start engine or - connect to 230V power supply

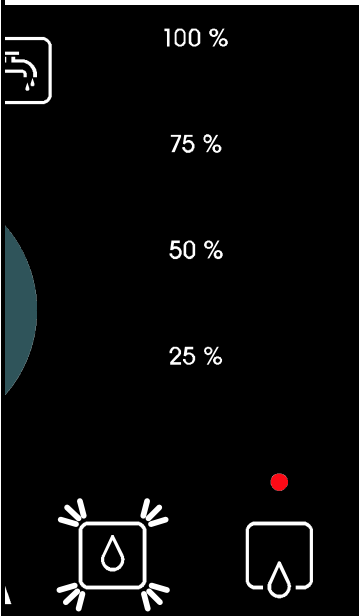
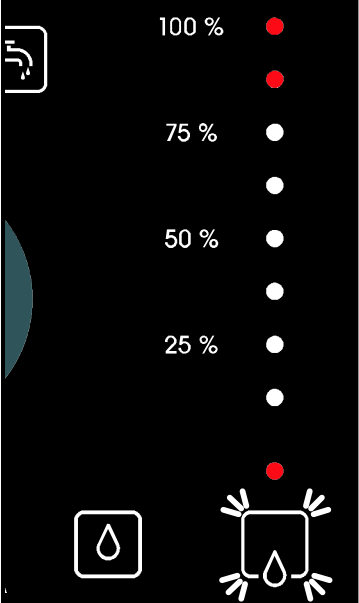
Alarm	Possible cause	Remedy
	<p>On display of the "Water Tank" fill level: The water tank is empty</p>	<p>Fill tank.</p>
	<p>On display of the "Waste Water Tank" fill level: The waste water tank is full.</p>	<p>Empty tank.</p>

4.2 Faults

A flat battery or defective fuse is the cause of most faults in the 12V system.



For targeted fault location and troubleshooting, the battery must be fully charged **and** the system must be connected to the 230V mains supply.

Start the engine

If the leisure battery is discharged, the 12V supply can be re-established by starting the engine.

Flat vehicle fuses

If fuses are blown: Refer to the instruction manual for the relevant EBL... electroblock for information on voltage distribution and fusing. .

When it is not possible to rectify a fault based on the following table, please contact Schaudt customer service (for address, see Page 11).

Fault	Possible cause	Remedy
12V supply does not function (or some areas are not powered).	12V main switch is switched off.	12V main switch must be switched on.
	Fuse blown.	See electroblock EBL... instruction manual. .
12V indicator LED does not illuminate.	12V main switch is switched off.	12V main switch must be switched on.
	Leisure battery not charged, battery monitor has switched off.	Charge the leisure battery.
	Fuse blown.	See electroblock EBL... instruction manual. .
Leisure battery is flat.	Leisure battery is discharged.	Immediately charge the leisure battery. The leisure battery is damaged beyond repair if left totally discharged for a lengthy period.
	The battery can be discharged by inactive consumers such as the frost protection valve in the heater system.	Prior to leaving the motorhome standing for long periods, fully charge the living area battery and use the battery isolator (also refer to the instruction manual of the electroblock).
The LED mains indicator does not illuminate although the 230V mains supply is connected.	The mains connection is dead.	Check the mains supply (e.g. camping site).
	The power cutout to the electroblock has tripped or is disabled.	Reset power cutout.

5 Technical details

Dimensions	Approx. 120 x 120 x 45 including plug connections and rotary/press-in encoder
Weight	Approx. 150 g
Front panel	Acryl glass, printed on rear
Colour	Black
Storage temperature	- 20° C ... 70° C
Operating temperature	- 20° C ... 50° C
Protection rating	Front: IP50 Rear: IP00
Humidity	Only use in dry environments. Condensation not permitted.
Operating voltage	12V (10 - 14.5V), supply via caravan power supply or electroblock
Fill level reading	The fill level reading is only applicable for plastic water tanks.
CE marked	Yes

6 Maintenance

The LT 50 control panel requires no maintenance.

7 Cleaning

Clean the front plate with a soft, slightly damp cloth and a mild detergent. Never use spirit, thinners or similar substances. Do not allow fluid to penetrate into the control panel.

- © No part of this manual may be reproduced, translated or copied without express written permission.

Appendix

A Customer service

Customer service address Schaudt GmbH, Elektrotechnik & Apparatebau
Planckstraße 8
D-88677 Markdorf

- Phone: +49 7544 9577-16
- Email: kundendienst@schaudt-gmbh.de
- Web: www.schaudt-gmbh.de

Send in device Returning a faulty device:

- Complete and enclose the fault report, see Appendix B.
- Send it to the addressee (free delivery).

B Fault report

In the event of damage, please fill in the fault report and send it with the faulty device to the manufacturer.

Device type: _____
Item no.: _____
Vehicle: Manufacturer: _____
 Model: _____
 Own installation? Yes No
 Upgrade? Yes No
Upstream overvoltage protection? Yes No

Following fault has occurred (please tick):

- Electrical consumers do not work - which?
(please specify below)
- Switching on and off not possible
- Persistent fault
- Intermittent fault/loose contact

Other comments:

C EC Declaration of Conformity

Schaudt GmbH hereby confirms that model

- LT 50 control panel

complies with the relevant regulations. The Declaration of Conformity can be requested at any time from the address specified on the cover page, or be downloaded from www.schaudt-gmbh.de.

D Wiring diagram

Rear side at top

